

RIVNUT RNFFS SERIES

Description	Flush Flange, Plain Body
Material	Steel
Finish	Zinc



Dimensions in millimetres.

Part Number	Thread Size	Hole Size +0.1	A -0.15	B ±0.3	C ±0.3	D ±0.2	Grip Range
RNFFS03	M3	4.8	4.80	9.00	5.30	0.40	0.5 ~ 1.5
RNFFS04	M4	6.4	6.30	10.40	7.10	0.45	0.5 ~ 2.0
RNFFS05	M5	7.2	7.10	12.00	8.10	0.50	0.5 ~ 3.0
RNFFS06	M6	9.6	9.50	15.00	10.50	0.60	0.8 ~ 3.0
RNFFS08	M8	10.6	10.50	16.00	11.50	0.60	0.9 ~ 3.0
RNFFS10	M10	12.7	12.70	19.00	13.90	0.70	1.0 ~ 4.0

PLEASE NOTE – NOT ALL STYLES & SIZES ARE HELD IN STOCK AT ALL TIMES. PLEASE CONTACT US TO CHECK AVAILABILITY. MINIMUM ORDER QUANTITIES APPLY.

Dafra Fastening Systems - Rivets Rivnuts & Tooling

1 / 7 Jarrah Dr, Braeside, VIC 3195, Australia

P: +61 3 9555 6872 | F: +61 3 9555 0803

E: sales@dafra.com.au | dafra.com.au



RIVNUT RNFFA SERIES

Description	Flush Flange, Splined Body
Material	Aluminium
Finish	Natural

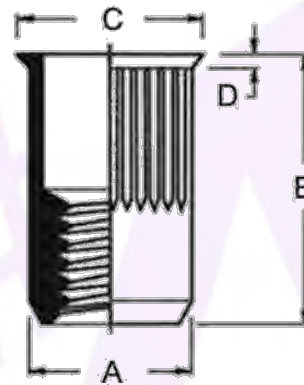

Dimensions in millimetres.

Part Number	Thread Size	Hole Size +0.1	A +0 / -0.15	B ±0.3	C ±0.3	D ±0.1	Grip Range
RNFFA0315	M3	5.1	5.0	9.5	6.0	0.5	0.8 ~ 2.5
RNFFA0425	M4	6.1	6.0	11.0	7.0	0.5	0.8 ~ 2.5
RNFFA0435				12.0			2.5 ~ 3.5
RNFFA0525	M5	7.1	7.0	12.0	8.0	0.5	0.8 ~ 2.5
RNFFA0535				13.0			2.5 ~ 3.5
RNFFA0625	M6	9.1	9.0	14.0	10.0	0.5	1.0 ~ 2.5
RNFFA0640				15.5			2.5 ~ 4.0
RNFFA0825	M8	11.1	11.0	15.5	12.0	0.7	1.0 ~ 2.5
RNFFA0840				17.0			2.5 ~ 4.0
RNFFA01025	M10	13.1	13.0	16.0	14.0	0.7	1.0 ~ 2.5
RNFFA01040							

PLEASE NOTE – NOT ALL STYLES & SIZES ARE HELD IN STOCK AT ALL TIMES. PLEASE CONTACT US TO CHECK AVAILABILITY. MINIMUM ORDER QUANTITIES APPLY.

Dafra Fastening Systems - Rivets Rivnuts & Tooling

1 / 7 Jarrah Dr, Braeside, VIC 3195, Australia

P: +61 3 9555 6872 | F: +61 3 9555 0803

E: sales@dafra.com.au | dafra.com.au



RIVNUT RNLFA SERIES

Description	Large Flange, Splined Body
Material	Aluminium
Finish	Plain

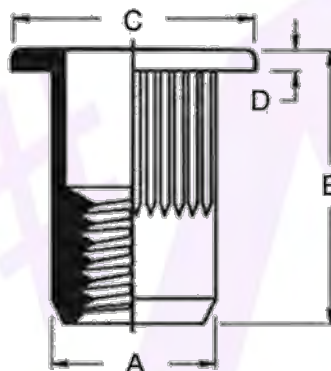

Dimensions in millimetres.

Part Number	Thread Size	Hole Size +0.1	A +0 / -0.15	B ±0.3	C ±0.3	D ±0.1	Grip Range
RNLFA0315	M3	5.1	5.0	9.0	8.0	0.8	0.8 ~ 2.5
RNLFA0425	M4	6.1	6.0	10.5	9.	0.8	0.8 ~ 2.5
RNLFA0435				11.5			2.5 ~ 3.5
RNLFA0525	M5	7.1	7.0	11.5	10.0	1.0	0.8 ~ 2.5
RNLFA0535				12.5			2.5 ~ 3.5
RNLFA0625	M6	9.1	9.0	13.5	12.5	1.5	1.0 ~ 2.5
RNLFA0640				15.0			2.5 ~ 4.0
RNLFA0825	M8	11.1	11.0	15.0	14.5	1.5	1.0 ~ 2.5
RNLFA0840				16.5			2.5 ~ 4.0
RNLFA1025	M10	13.1	13.0	15.5	16.5	1.5	1.0 ~ 2.5
RNLFA1040				17.0			2.5 ~ 4.0

PLEASE NOTE – NOT ALL STYLES & SIZES ARE HELD IN STOCK AT ALL TIMES. PLEASE CONTACT US TO CHECK AVAILABILITY. MINIMUM ORDER QUANTITIES APPLY.

Dafra Fastening Systems - Rivets Rivnuts & Tooling

1 / 7 Jarrah Dr, Braeside, VIC 3195, Australia

P: +61 3 9555 6872 | F: +61 3 9555 0803

E: sales@dafra.com.au | dafra.com.au



RIVNUT RNFFST SERIES

Description	Flush Flange, Splined Body
Material	Stainless Steel
Finish	Plain

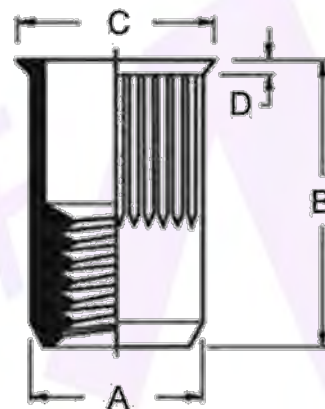

Dimensions in millimetres.

Part Number	Thread Size	Hole Size +0.1 / -0	A Max.	B +0.5 / -0	C ±0.3	D +0.3 / -0	Grip Range
RNFFST03	M3	5.0	5.0	9.0	6.0	0.5	0.5 ~ 2.0
RNFFST04	M4	6.0	6.0	11.0	7.0	0.5	0.5 ~ 2.5
RNFFST04L				12.5			2.5 ~ 4.0
RNFFST05	M5	7.0	7.0	12.0	8.0	0.5	0.5 ~ 3.0
RNFFST05L				13.5			3.0 ~ 4.5
RNFFST06	M6	9.0	9.0	14.0	10.0	0.5	0.5 ~ 3.0
RNFFST06L				16.0			3.0 ~ 5.0
RNFFST08	M8	11.0	11.0	16.0	12.0	0.5	0.5 ~ 3.0
RNFFST08L				18.5			3.0 ~ 5.5
RNFFST10	M10	13.0	13.0	19.0	14.2	0.8	1.0 ~ 3.5
RNFFST10L				21.5			3.5 ~ 6.0
RNFFST12-15	M12	15.0	14.9	22.5	16.5	0.85	0.5 ~ 3.5

PLEASE NOTE – NOT ALL STYLES & SIZES ARE HELD IN STOCK AT ALL TIMES. PLEASE CONTACT US TO CHECK AVAILABILITY. MINIMUM ORDER QUANTITIES APPLY.

Dafra Fastening Systems - Rivets Rivnuts & Tooling

1 / 7 Jarrah Dr, Braeside, VIC 3195, Australia

P: +61 3 9555 6872 | F: +61 3 9555 0803

E: sales@dafra.com.au | dafra.com.au



RIVNUT RNLFST SERIES

Description	Large Flange, Splined Body
Material	Stainless Steel
Finish	Plain

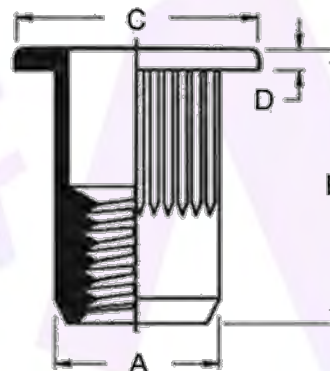

Dimensions in millimetres.

Part Number	Thread Size	Hole Size +0.1 / -0	A Max.	B ±0.3	C +0 / -0.5	D ±0.1	Grip Range
RNLFST0325	M3	5.0	5.0	9.0	8.0	0.8	0.3 ~ 2.0
RNLFST0425	M4	6.0	6.0	11.0	9.0	1.0	0.3 ~ 2.5
RNLFST0435				12.5			2.5 ~ 4.0
RNLFST0525	M5	7.0	7.0	12.0	10.0	1.0	0.3 ~ 3.0
RNLFST0535				13.5			3.0 ~ 4.5
RNLFST0625	M6	9.0	9.0	14.0	12.0	1.5	0.5 ~ 3.0
RNLFST0640				16.0			3.0 ~ 5.0
RNLFST0825	M8	11.0	11.0	16.0	15.0	1.5	0.5 ~ 3.0
RNLFST0840				18.5			3.0 ~ 5.5
RNLFST1025	M10	13.0	13.0	19.0	17.0	2.0	1.0 ~ 3.5
RNLFST1040				21.5			3.5 ~ 6.0

PLEASE NOTE – NOT ALL STYLES & SIZES ARE HELD IN STOCK AT ALL TIMES. PLEASE CONTACT US TO CHECK AVAILABILITY. MINIMUM ORDER QUANTITIES APPLY.

Dafra Fastening Systems - Rivets Rivnuts & Tooling

1 / 7 Jarrah Dr, Braeside, VIC 3195, Australia

P: +61 3 9555 6872 | F: +61 3 9555 0803

E: sales@dafra.com.au | dafra.com.au



RIVNUT RNFFSTA4 SERIES

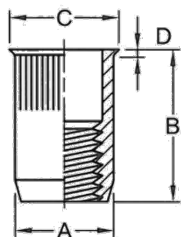

Description	Flush Flange, Splined Body
Material	Stainless Steel – A4
Finish	Plain

Dimensions in millimetres.

Part Number	Thread Size	Hole Size +0.1 / -0	A Max.	B +0.5 / -0	C ±0.3	D +0.3 / -0	Grip Range
RNFFSTA40325	M3	5.0	5.0	9.0	6.0	0.50	0.5 ~ 2.0
RNFFSTA40425	M4	6.0	6.0	11.0	7.0	0.50	0.5 ~ 2.5
RNFFSTA40525	M5	7.0	7.0	12.0	8.0	0.50	0.5 ~ 3.0
RNFFSTA40625	M6	9.0	9.0	14.0	10.0	0.50	0.5 ~ 3.0
RNFFSTA40825	M8	11.0	11.0	16.0	12.0	0.50	0.5 ~ 3.0
RNFFSTA401025	M10	13.0	13.0	19.0	14.2	0.80	1.0 ~ 3.5

RNFFSTA4 SERIES RIVNUTS ARE AVAILABLE BY SPECIAL ORDER ONLY & MINIMUM ORDER QUANTITIES APPLY

RIVNUT RNLFSTA4 SERIES

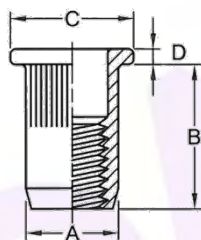

Description	Large Flange, Splined Body
Material	Stainless Steel – A4
Finish	Plain

Dimensions in millimetres.

Part Number	Thread Size	Hole Size +0.1 / -0	A Max.	B ±0.3	C +0 / -0.5	D ±0.1	Grip Range
RNLFSTA40325	M3	5.0	5.0	9.0	8.0	0.80	0.3 ~ 2.0
RNLFSTA40425	M4	6.0	6.0	11.0	9.0	1.00	0.3 ~ 2.5
RNLFSTA40525	M5	7.0	7.0	12.0	10.0	1.00	0.3 ~ 3.0
RNLFSTA40625	M6	9.0	9.0	14.0	12.0	1.50	0.5 ~ 3.0
RNLFSTA40825	M8	11.0	11.0	16.0	15.0	1.50	0.5 ~ 3.0
RNLFSTA401025	M10	13.0	13.0	19.0	17.0	2.00	1.0 ~ 3.5

RNLFSTA4 SERIES RIVNUTS ARE AVAILABLE BY SPECIAL ORDER ONLY & MINIMUM ORDER QUANTITIES APPLY

Dafra Fastening Systems - Rivets Rivnuts & Tooling

1 / 7 Jarrah Dr, Braeside, VIC 3195, Australia

P: +61 3 9555 6872 | F: +61 3 9555 0803

E: sales@dafra.com.au | dafra.com.au



RIVNUT RNFFSSE SERIES

Description	Flush Flange, Splined Body
Material	Steel
Finish	Zinc

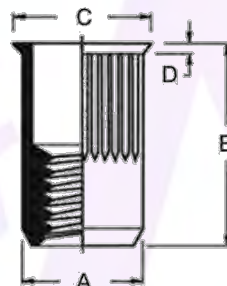

Dimensions in millimetres.

Part Number	Thread Size	Hole Size +0.1	A -0.15	B ±0.3	C ±0.25	D ±0.2	Grip Range
RNFFSSE03	M3	5.0	5.0	9.00	5.70	0.40	0.5 ~ 1.5
RNFFSSE04	M4	6.0	6.0	9.95	7.0	0.45	0.5 ~ 2.0
RNFFSSE04L				12.00			2.5 ~ 4.0
RNFFSSE05	M5	7.0	7.0	12.00	8.0	0.50	0.5 ~ 2.5
RNFFSSE05L				14.00		0.55	2.5 ~ 4.0
RNFFSSE06	M6	9.0	9.0	15.00	10.0	0.50	0.7 ~ 3.0
RNFFSSE06L				17.00			3.0 ~ 5.0
RNFFSSE08	M8	11.0	11.0	16.00	12.0	0.50	1.0 ~ 3.0
RNFFSSE08L				18.50			3.0 ~ 5.5
RNFFSSE10	M10	13.0	13.0	20.50	14.10	0.60	1.0 ~ 4.0
RNFFSSE10L				23.50			4.0 ~ 6.0
RNFFSSE12-16	M12	16.0	15.9	24.20	17.60	0.75	1.0 ~ 4.0

PLEASE NOTE – NOT ALL STYLES & SIZES ARE HELD IN STOCK AT ALL TIMES. PLEASE CONTACT US TO CHECK AVAILABILITY. MINIMUM ORDER QUANTITIES APPLY.

Dafra Fastening Systems - Rivets Rivnuts & Tooling

1 / 7 Jarrah Dr, Braeside, VIC 3195, Australia

P: +61 3 9555 6872 | F: +61 3 9555 0803

E: sales@dafra.com.au | dafra.com.au



RIVNUT RNLFSSE SERIES

Description	Large Flange, Splined Body
Material	Steel
Finish	Zinc

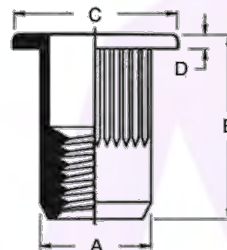

Dimensions in millimetres.

Part Number	Thread Size	Hole Size	A -0.15	B ±0.3	C ±0.3	D ±0.2	Grip Range
RNLFSSE03	M3	5.0	5.0	10.5	8.0	0.7	0.5 ~ 2.0
RNLFSSE04	M4	6.0	6.0	11.0	9.0	0.8	0.5 ~ 2.5
RNLFSSE05	M5	7.0	7.0	13.0	10.0	1.0	0.7 ~ 3.0
RNLFSSE05L				14.5			3.0 ~ 4.5
RNLFSSE06	M6	9.0	9.0	16.5	13.0	1.5	0.8 ~ 3.0
RNLFSSE06L				18.5			3.0 ~ 5.0
RNLFSSE08	M8	11.0	11.0	17.5	16.0	1.5	1.0 ~ 3.0
RNLFSSE08L				21.0			3.0 ~ 5.5
RNLFSSE10	M10	13.0	13.0	24.0	19.0	2.0	1.0 ~ 4.5
RNLFSSE10L				25.5			4.0 ~ 6.5
RNLFSSE12-15	M12	15.0	14.9	25.2	21.7	2.0	1.0 ~ 4.5
RNLFSSE12-15L				27.5			4.0 ~ 6.5
RNLFSSE12-16	M12	16.0	15.0	25.0	22.0	2.0	1.0 ~ 4.0
RNLFSSE12-16L				28.0			3.5 ~ 6.0

PLEASE NOTE – NOT ALL STYLES & SIZES ARE HELD IN STOCK AT ALL TIMES. PLEASE CONTACT US TO CHECK AVAILABILITY. MINIMUM ORDER QUANTITIES APPLY.

Dafra Fastening Systems - Rivets Rivnuts & Tooling

1 / 7 Jarrah Dr, Braeside, VIC 3195, Australia

P: +61 3 9555 6872 | F: +61 3 9555 0803

E: sales@dafra.com.au | dafra.com.au



RIVNUT RNFFSSi SERIES

Description	Flush Flange, Splined Body
Material	Steel
Finish	Zinc

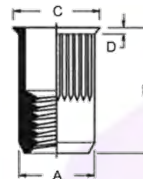

Dimensions in inches.

Part Number	Thread Size	Hole Size +.006/-0.00	A +.006/-0.00	B ±.015	C ±.010/±.015*	D ±.002	Grip Range
RNFFSSi316	3/16 UNC	.297	.297	.475	.340	.019	.020 ~ .130
RNFFSSi14	1/4 UNC	.391	.391	.580	.455	.022	.027 ~ .165
RNFFSSi516	5/16 UNC	.531	.531	.690	.595*	.022	.027 ~ .150
RNFFSSi38	3/8 UNC	.531	.531	.690	.595*	.022	.027 ~ .150

PLEASE NOTE – NOT ALL STYLES & SIZES ARE HELD IN STOCK AT ALL TIMES. PLEASE CONTACT US TO CHECK AVAILABILITY. MINIMUM ORDER QUANTITIES APPLY.

RIVNUT RNLFSSi SERIES

Description	Large Flange, Splined Body
Material	Steel
Finish	Zinc

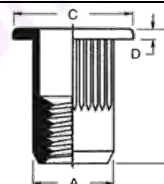

Dimensions in inches.

Part Number	Thread Size	Hole Size +.006/-0.00	A +.006/-0.00	B ±.015	C ±.010/±.025*	D ±.003	Grip Range
RNLFSSi316	3/16 UNC	.297	.297	.475	.415	.030	.020 ~ .130
RNLFSSi14	1/4 UNC	.391	.391	.580	.500	.030	.027 ~ .165
RNLFSSi516	5/16 UNC	.531	.531	.690	.685*	.035	.027 ~ .150
RNLFSSi38	3/8 UNC	.531	.531	.690	.685*	.035	.027 ~ .150

PLEASE NOTE – NOT ALL STYLES & SIZES ARE HELD IN STOCK AT ALL TIMES. PLEASE CONTACT US TO CHECK AVAILABILITY. MINIMUM ORDER QUANTITIES APPLY.

Dafra Fastening Systems - Rivets Rivnuts & Tooling

1 / 7 Jarrah Dr, Braeside, VIC 3195, Australia

P: +61 3 9555 6872 | F: +61 3 9555 0803

E: sales@dafra.com.au | dafra.com.au



RIVNUT RNFFSDK SERIES

Description	Flush Flange, Splined Body
Material	Steel
Finish	Zinc

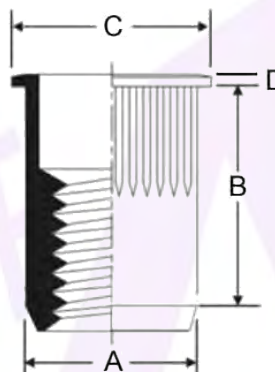

Dimensions in millimetres.

Part Number	Thread Size	Hole Size +0.1	A +0.05 / -0.15	B ±0.4	C ±0.3	D ±0.1	Grip Range
RNFFSDK04	M4	6.75	6.70	11.10	7.85	0.50	0.5 ~ 2.0
RNFFSDK04L				12.40			2.0 ~ 3.3
RNFFSDK05	M5	7.60	7.50	12.50	8.65	0.50	05. ~ 3.3
RNFFSDK05L				15.30			3.3 ~ 5.7
RNFFSDK06	M6	10.00	9.90	15.30	11.60	0.55	0.7 ~ 4.2
RNFFSDK06L				17.80			4.2 ~ 6.6
RNFFSDK08	M8	13.50	13.45	18.00	15.10	0.55	0.7 ~ 3.8
RNFFSDK08L				21.00			3.8 ~ 7.9
RNFFSDK10	M10	13.50	13.45	18.00	15.10	0.55	0.7 ~ 3.8
RNFFSDK10L				21.00			3.8 ~ 7.9

PLEASE NOTE – NOT ALL STYLES & SIZES ARE HELD IN STOCK AT ALL TIMES. PLEASE CONTACT US TO CHECK AVAILABILITY. MINIMUM ORDER QUANTITIES APPLY.

Dafra Fastening Systems - Rivets Rivnuts & Tooling

1 / 7 Jarrah Dr, Braeside, VIC 3195, Australia

P: +61 3 9555 6872 | F: +61 3 9555 0803

E: sales@dafra.com.au | dafra.com.au



RIVNUT RNLFSDL SERIES

Description	Large Flange, Splined Body
Material	Steel
Finish	Zinc

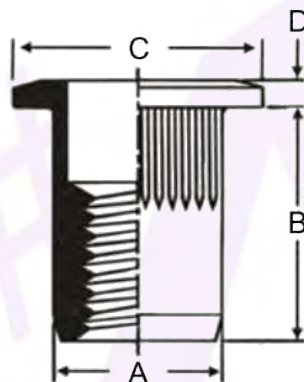

Dimensions in millimetres.

Part Number	Thread Size	Hole Size +0.1	A +0.05 / -0.15	B ±0.4	C ±0.3 *+0.64	D ±0.1	Grip Range
RNLFSDL04	M4	6.75	6.70	11.45	9.90	0.75	0.5 ~ 2.0
RNLFSDL04L				12.70			2.0 ~ 3.3
RNLFSDL05	M5	7.60	7.50	12.85	10.55	0.75	0.5 ~ 3.3
RNLFSDL05L				15.50			3.3 ~ 5.7
RNLFSDL06	M6	10.00	9.90	15.50	12.70	0.75	0.7 ~ 4.2
RNLFSDL06L				18.00			4.2 ~ 6.6
RNLFSDL08	M8	13.50	13.45	18.40	*17.40	0.90	0.7 ~ 3.8
RNLFSDL08L				21.35			3.8 ~ 7.9
RNLFSDL10	M10	13.50	13.45	18.40	*17.40	0.90	0.7 ~ 3.8
RNLFSDL10L				21.35			3.8 ~ 7.9

PLEASE NOTE – NOT ALL STYLES & SIZES ARE HELD IN STOCK AT ALL TIMES. PLEASE CONTACT US TO CHECK AVAILABILITY. MINIMUM ORDER QUANTITIES APPLY.

Dafra Fastening Systems - Rivets Rivnuts & Tooling

1 / 7 Jarrah Dr, Braeside, VIC 3195, Australia

P: +61 3 9555 6872 | F: +61 3 9555 0803

E: sales@dafra.com.au | dafra.com.au



RIVNUT RNFFSTDK SERIES

Description	Flush Flange, Splined Body
Material	Stainless Steel – A2
Finish	Plain

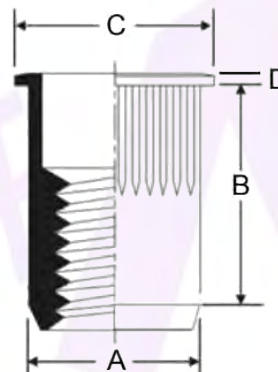

Dimensions in millimetres.

Part Number	Thread Size	Hole Size +0.15 / -0	A Max	B ±0.4	C ±0.3	D ±0.1	Grip Range
RNFFSTDK04	M4	6.75	6.73	10.70	7.90	0.60	0.5 ~ 2.0
RNFFSTDK04L				11.90			2.0 ~ 3.3
RNFFSTDK05	M5	7.60	7.52	12.10	8.60	0.60	0.5 ~ 3.3
RNFFSTDK05L				14.90			3.3 ~ 5.7
RNFFSTDK06	M6	10.00	9.91	14.70	11.60	0.60	0.7 ~ 4.2
RNFFSTDK06L				17.30			4.2 ~ 6.6
RNLFSTDL08	M8	13.50	13.46	17.50	*16.30	0.80	0.7 ~ 3.8
RNLFSTDL08L				20.50			3.8 ~ 7.9
RNLFSTDL10	M10	13.50	13.46	17.50	*16.30	0.80	0.7 ~ 3.8
RNLFSTDL10L				20.50			3.8 ~ 7.9

PLEASE NOTE – NOT ALL STYLES & SIZES ARE HELD IN STOCK AT ALL TIMES. PLEASE CONTACT US TO CHECK AVAILABILITY. MINIMUM ORDER QUANTITIES APPLY.

Dafra Fastening Systems - Rivets Rivnuts & Tooling

1 / 7 Jarrah Dr, Braeside, VIC 3195, Australia

P: +61 3 9555 6872 | F: +61 3 9555 0803

E: sales@dafra.com.au | dafra.com.au



RIVNUT RNLFSTDL SERIES

Description	Large Flange, Splined Body
Material	Stainless Steel – A2
Finish	Plain

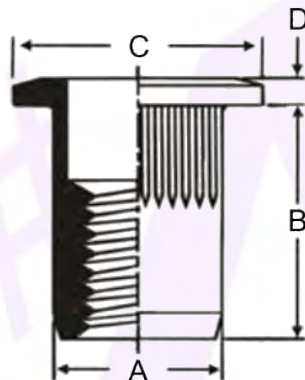

Dimensions in millimetres.

Part Number	Thread Size	Hole Size +0.15 / -0	A Max	B ±0.4	C ±0.3 *±0.64	D ±0.1	Grip Range
RNLFSTDL04	M4	6.75	6.73	10.70	9.90	0.80	0.5 ~ 2.0
RNLFSTDL04L				11.90			2.0 ~ 3.3
RNLFSTDL05	M5	7.60	7.52	12.10	10.50	0.80	0.5 ~ 3.3
RNLFSTDL05L				14.90			3.3 ~ 5.7
RNLFSTDL06	M6	10.00	9.91	14.70	12.70	1.00	0.7 ~ 4.2
RNLFSTDL06L				17.30			4.2 ~ 6.6
RNLFSTDL08	M8	13.50	13.46	17.50	*17.40	1.00	0.7 ~ 3.8
RNLFSTDL08L				20.50			3.8 ~ 7.9
RNLFSTDL10	M10	13.50	13.46	17.50	*17.40	1.00	0.7 ~ 3.8
RNLFSTDL10L				20.50			3.8 ~ 7.9

PLEASE NOTE – NOT ALL STYLES & SIZES ARE HELD IN STOCK AT ALL TIMES. PLEASE CONTACT US TO CHECK AVAILABILITY. MINIMUM ORDER QUANTITIES APPLY.

Dafra Fastening Systems - Rivets Rivnuts & Tooling

1 / 7 Jarrah Dr, Braeside, VIC 3195, Australia

P: +61 3 9555 6872 | F: +61 3 9555 0803

E: sales@dafra.com.au | dafra.com.au



RIVNUT RNFFSH SERIES

Description	Flush Flange, Half Hex Body
Material	Steel
Finish	Zinc

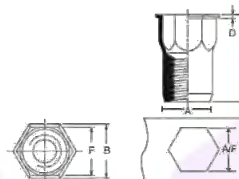

Dimensions in millimetres.

Part Number	Thread Size	Hex Hole Size A/F +0.2	A -0.15	B ±0.3	D ±0.15	M ±0.35	Grip Range
RNFFSH04	M4	6.4	6.35	7.00	0.40	10.40	0.5 ~ 2.5
RNFFSH05	M5	7.20	7.10	8.10	0.50	12.00	0.5 ~ 3.0
RNFFSH06	M6	9.60	9.50	10.50	0.50	14.50	0.7 ~ 3.3
RNFFSH08	M8	10.60	10.50	11.50	0.50	16.00	0.7 ~ 3.3
RNFFSH10	M10	12.70	12.70	14.00	0.50	18.80	1.0 ~ 3.5

PLEASE NOTE – NOT ALL STYLES & SIZES ARE HELD IN STOCK AT ALL TIMES. PLEASE CONTACT US TO CHECK AVAILABILITY. MINIMUM ORDER QUANTITIES APPLY.

RIVNUT RNLFSH SERIES

Description	Large Flange, Half Hex Body
Material	Steel
Finish	Zinc

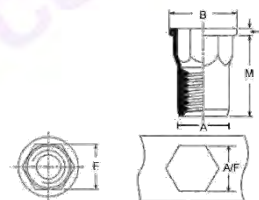

Dimensions in millimetres.

Part Number	Thread Size	Hex Hole Size A/F +0.2	A -0.15	B ±0.3	D ±0.2	M ±0.35	Grip Range
RNLFSH05	M5	7.0	7.0	10.0	1.0	13.8	0.50 ~ 3.0
RNLFSH06	M6	9.0	9.0	13.0	1.5	16.0	0.50 ~ 3.0
RNLFSH08	M8	11.0	11.0	16.0	1.5	18.0	0.50 ~ 3.0

PLEASE NOTE – NOT ALL STYLES & SIZES ARE HELD IN STOCK AT ALL TIMES. PLEASE CONTACT US TO CHECK AVAILABILITY. MINIMUM ORDER QUANTITIES APPLY.

Daфра Fastening Systems - Rivets Rivnuts & Tooling

1 / 7 Jarrah Dr, Braeside, VIC 3195, Australia

P: +61 3 9555 6872 | F: +61 3 9555 0803

E: sales@dafra.com.au | dafra.com.au

RIVNUT RNFFSFBH SERIES

Description	Flush Flange, Full Hex Body
Material	Steel
Finish	Zinc



Dimensions in millimetres.

Part Number	Thread Size	Hex Hole Size A/F +0.1	A -0.2	B ±0.35	L ±0.35	P ±0.2	SE Min	Grip Range
RNFFSFBH04	M4	6.1	6.0	9.0	11.2	0.8	6.8	0.5 ~ 2.5
RNFFSFBH05	M5	7.1	7.0	10.0	13.0	1.0	8.0	0.5 ~ 3.0
RNFFSFBH06	M6	9.1	9.0	13.0	16.0	1.5	10.3	0.5 ~ 3.0
RNFFSFBH08	M8	11.1	11.0	16.0	18.0	1.5	12.6	0.5 ~ 3.0
RNFFSFBH10	M10	13.1	13.0	19.0	24.0	2.0	14.0	1.0 ~ 4.5

PLEASE NOTE – NOT ALL STYLES & SIZES ARE HELD IN STOCK AT ALL TIMES. PLEASE CONTACT US TO CHECK AVAILABILITY. MINIMUM ORDER QUANTITIES APPLY.

RIVNUT RNLFSFBH SERIES

Description	Large Flange, Full Hex Body
Material	Steel
Finish	Zinc

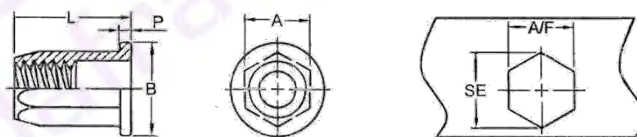

Dimensions in

millimetres.

Part Number	Thread Size	Hex Hole Size A/F +0.1	A -0.2	B ±0.35	L ±0.2	P ±0.35	SE Min	Grip Range
RNLFSFBH05	M5	7.1	7.0	10.0	13.0	1.0	8.0	0.5 ~ 3.0
RNLFSFBH06	M6	9.1	9.0	13.0	16.0	1.5	10.3	0.5 ~ 3.0
RNLFSFBH08	M8	11.1	11.0	16.0	18.0	1.5	12.6	0.5 ~ 3.0

PLEASE NOTE – NOT ALL STYLES & SIZES ARE HELD IN STOCK AT ALL TIMES. PLEASE CONTACT US TO CHECK AVAILABILITY. MINIMUM ORDER QUANTITIES APPLY.

Dafra Fastening Systems - Rivets Rivnuts & Tooling

1 / 7 Jarrah Dr, Braeside, VIC 3195, Australia

P: +61 3 9555 6872 | F: +61 3 9555 0803

E: sales@dafra.com.au | dafra.com.au



RIVNUT RNFFSTH SERIES

Description	Flush Flange, Half Hex Body
Material	Stainless Steel – A2
Finish	Plain

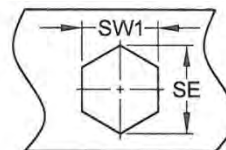
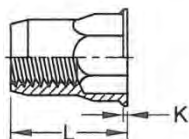

Dimensions in millimetres.

Part Number	Thread Size	Hex Hole Size SW1	SW +0 / -0.15	SE Min	D ±0.30	K +0.3 / -0	L +0.5 / -0	Grip Range
RNFFSTH04	M4	6.1	6.0	6.8	7.0	0.5	11.0	0.5 ~ 2.5
RNFFSTH05	M5	7.1	7.0	7.9	8.0	0.5	12.0	0.5 ~ 3.0
RNFFSTH06	M6	9.1	9.0	10.2	10.0	0.5	14.0	0.5 ~ 3.0
RNFFSTH08	M8	11.1	11.0	12.4	12.0	0.5	16.0	0.5 ~ 3.0
RNFFSTH10	M10	13.1	13.0	14.8	14.2	0.7	19.0	1.0 ~ 3.5

PLEASE NOTE – NOT ALL STYLES & SIZES ARE HELD IN STOCK AT ALL TIMES. PLEASE CONTACT US TO CHECK AVAILABILITY. MINIMUM ORDER QUANTITIES APPLY.

RIVNUT RNLFSTH SERIES

Description	Large Flange, Half Hex Body
Material	Stainless Steel – A2
Finish	Plain

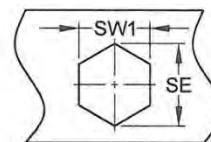
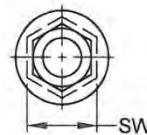
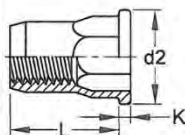

Dimensions in millimetres.

Part Number	Thread Size	Hex Hole Size SW1	SW +0 / -0.15	SE Min	d2 +0.5 / -0	K ±0.1	L ±0.3	Grip Range
RNLFSTH05	M5	7.1	7.0	7.9	10.0	1.0	12.0	0.5 ~ 3.0
RNLFSTH06	M6	9.1	9.0	10.2	12.0	1.5	14.0	0.5 ~ 3.0
RNLFSTH08	M8	11.1	11.0	12.4	14.5	1.5	14.5	0.5 ~ 3.0

PLEASE NOTE – NOT ALL STYLES & SIZES ARE HELD IN STOCK AT ALL TIMES. PLEASE CONTACT US TO CHECK AVAILABILITY. MINIMUM ORDER QUANTITIES APPLY.

Dafra Fastening Systems - Rivets Rivnuts & Tooling

1 / 7 Jarrah Dr, Braeside, VIC 3195, Australia

P: +61 3 9555 6872 | F: +61 3 9555 0803

E: sales@dafra.com.au | dafra.com.au



RIVNUT RNFFSSECE SERIES

Description	Flush Flange, Closed End
Material	Steel
Finish	Zinc

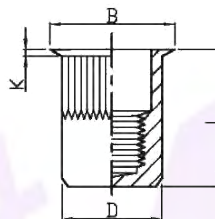

Dimensions in millimetres.

Part Number	Thread Size	Hole Size +0.1	D -0.15	L ±1.0	B ±0.3	K ±0.2	Grip Range
RNFFSSECE05	M5	7.0	7.0	18.00	7.90	0.50	0.5 ~ 2.5
RNFFSSECE06	M6	9.0	9.0	21.50	10.00	0.50	0.5 ~ 3.0
RNFFSSECE08	M8	11.0	11.0	22.50	12.00	0.50	1.0 ~ 3.2

PLEASE NOTE – NOT ALL STYLES & SIZES ARE HELD IN STOCK AT ALL TIMES. PLEASE CONTACT US TO CHECK AVAILABILITY. MINIMUM ORDER QUANTITIES APPLY.

RIVNUT RNLFSSSECE SERIES

Description	Large Flange, Closed End
Material	Steel
Finish	Zinc

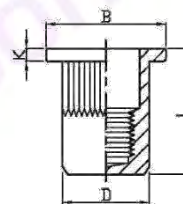

Dimensions in millimetres.

Part Number	Thread Size	Hole Size +0.1	D -0.15	L ±1.0	B ±0.3	K ±0.2	Grip Range
RNLFSSSECE05	M5	7.0	7.0	18.00	10.00	1.00	0.5 ~ 2.5
RNLFSSSECE06	M6	9.0	9.0	21.50	13.00	1.50	0.7 ~ 3.0
RNLFSSSECE08	M8	11.0	11.00	24.50	16.00	1.50	0.7 ~ 3.0

PLEASE NOTE – NOT ALL STYLES & SIZES ARE HELD IN STOCK AT ALL TIMES. PLEASE CONTACT US TO CHECK AVAILABILITY. MINIMUM ORDER QUANTITIES APPLY.

Dafra Fastening Systems - Rivets Rivnuts & Tooling

1 / 7 Jarrah Dr, Braeside, VIC 3195, Australia

P: +61 3 9555 6872 | F: +61 3 9555 0803

E: sales@dafra.com.au | dafra.com.au



JK NUT JK0 SERIES

Description	JK Nut
Material	Low Carbon Steel
Finish	Zinc Plate

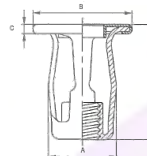

Dimensions in millimetres

Part Number	Thread Size	Hole Size +0.1	A Max.	B ±0.4	C ±0.3	D +2.0/-0.5	Grip Range
JK0401	M4	8.0	8.50	12.20	1.60	16.80	0.0 ~ 5.0
JK0402						22.00	5.0 ~ 10.0
JK0501	M5	10.0	10.50	14.00	1.60	18.40	0.0 ~ 5.0
JK0502						23.20	5.0 ~ 10.0
JK0601	M6	12.0	12.50	16.00	1.60	18.60	0.0 ~ 5.0
JK0602						22.90	5.0 ~ 10.0
JK0801	M8	15.0	15.50	18.00	1.60	20.00	0.0 ~ 5.0
JK0802						25.00	5.0 ~ 8.0

PLEASE NOTE – NOT ALL STYLES & SIZES ARE HELD IN STOCK AT ALL TIMES. PLEASE CONTACT US TO CHECK AVAILABILITY. MINIMUM ORDER QUANTITIES APPLY.

FOLDING NUT FN SERIES

Description	Folding Nut
Material	Low Carbon Steel
Finish	Zinc Plate

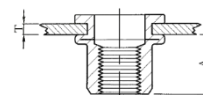
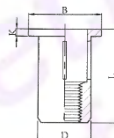

Dimensions in millimetres

Part Number	Thread Size	Hole Size +0.01	A Rer	D +0.07	B	K	L	Grip Range T
FN05	M5	7.5	9.6	7.4	12.7	1.0	22.0	0.5 ~ 4.5
FN06	M6	8.8	12.5	8.7	16.0	1.5	27.0	0.5 ~ 7.0
FN08	M8	11.1	14.3	11.0	19.0	1.6	30.5	1.0 ~ 7.0

PLEASE NOTE – NOT ALL STYLES & SIZES ARE HELD IN STOCK AT ALL TIMES. PLEASE CONTACT US TO CHECK AVAILABILITY. MINIMUM ORDER QUANTITIES APPLY.

Please note, a special DAFRA DNPM2312L long stroke tool is required for JK0 and FN Series rivnuts.

Dafra Fastening Systems - Rivets Rivnuts & Tooling

1 / 7 Jarrah Dr, Braeside, VIC 3195, Australia

P: +61 3 9555 6872 | F: +61 3 9555 0803

E: sales@dafra.com.au | dafra.com.au



RUBBER NUT JF SERIES

Description	Rubber Nut
Material	Brass / Stainless Steel nut
Finish	Neoprene Rubber / EPDM Rubber

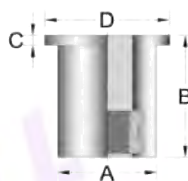

Dimensions in millimetres

Part Number	Thread Size	Hole Size +0.1	A Max.	B	C	D	Grip Range	Tightening Torque KGf/CM	Hardness +/- 5		
JF03100	M3 x 0.5	6.20	7.90	12.60	1.20	11.00	0.4 ~ 4.0	2.5~5.0	60		
JF03250	M3 x 0.5		6.10	24.90	0.90	14.00	9.5 ~ 13.0	2.5~5.0	70		
JF04100	M4 x 0.7	8.0	7.90	12.60	1.20	11.00	0.4 ~ 4.0	2.5~4.0	70		
JF04140	M4 x 0.7			14.20	1.50	19.05	0.4 ~ 4.4	2.5~4.0	70		
JF05150	M5 x 0.8	9.70	9.60	14.10	0.90	12.70	0.4 ~ 4.9	3.5~5.0	60		
JF05170	M5 x 0.8			17.00	1.00	14.00	0.85 ~ 5.9	3.0~7.0	60		
JF05180	M5 x 0.8			18.00	2.00	19.00	0.8 ~ 5.8	3.0~7.0	60		
JF05190	M5 x 0.8			20.95	4.70	18.95	0.8 ~ 5.8	4.0~7.0	60		
JF05192	M5 x 0.8			19.50	4.70	14.00	0.8 ~ 5.8	4.0~7.0	60		
JF05200	M5 x 0.8			21.50	0.90	14.00	4.0 ~ 10.0	3.0~9.0	60		
JF05250	M5 x 0.8			26.50	1.30	14.00	7.9 ~ 15.0	3.0~7.0	60		
JF05400	M5 x 0.8			39.00	1.30	14.00	20.5 ~ 30.0	6.0~10.0	60		
JF06150	M6 x 1.0			12.80	12.70	16.00	1.30	16.00	0.4 ~ 4.0	6.0~10.0	60
JF06160	M6 x 1.0					16.00	1.30	20.00	0.4 ~ 4.0	6.0~10.0	60
JF06190	M6 x 1.0	20.30	1.30			16.00	4.7 ~ 8.7	6.0~10.0	70		
JF06200	M6 x 1.0	21.10	4.75			19.05	0.8 ~ 4.7	8.0~10.0	70		
JF06250	M6 x 1.0	26.70	2.00			16.30	6.4 ~ 11.5	8.0~10.0	70		
JF08200	M8 x 1.25	16.00	15.90	18.30	3.20	21.50	0.4 ~ 4.0	10.0~15.0	60		
JF08250	M8 x 1.25	16.00	15.90	27.90	5.70	21.50	3.95 ~ 9.5	10.0~16.0	60		
JF08270	M8 x 1.25	19.15	19.05	27.00	4.75	31.75	0.38 ~ 11.10	45.0~55.0	60		
JF01024	M10 x 1.5	20.10	20.00	24.00	3.00	25.00	2.5 ~ 3.5	45.0~55.0	60		
JF01027	M10 x 1.5	19.15	19.05	27.00	4.75	29.50	0.38 ~ 11.10	45.0~55.0	60		
JF01027A	M10 x 1.5			27.00	4.75	31.75	0.38 ~ 11.10	45.0~55.0	60		
JF01226	M12 x 1.75	24.10	24.00	26.50	3.00	27.00	2.5 ~ 3.5	60.0~70.0	60		

PLEASE NOTE – NOT ALL STYLES & SIZES ARE HELD IN STOCK AT ALL TIMES. PLEASE CONTACT US TO CHECK AVAILABILITY. MINIMUM ORDER QUANTITIES APPLY.

Dafra Fastening Systems - Rivets Rivnuts & Tooling

1 / 7 Jarrah Dr, Braeside, VIC 3195, Australia

P: +61 3 9555 6872 | F: +61 3 9555 0803

E: sales@dafra.com.au | dafra.com.au



RIVSTUD RS SERIES

Description	Rivstud / Large Flange
Material	Steel
Finish	Zinc

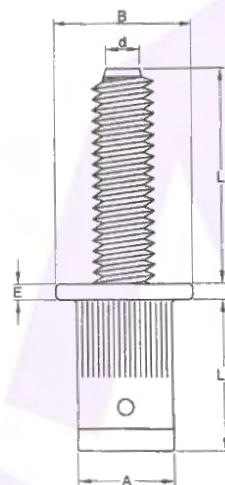

Dimensions in millimetres

Part Number	d	Hole Size +0.1/-0	A Max.	B ±0.30	E ±0.15	L ±0.50	L1 ±0.50	Grip Range
RSLF0425	M4	6.0	6.0	9.0	1.0	15.0	11.0	0.5 ~ 2.5
RSLF0530	M5	7.0	7.0	10.0	1.0	15.0	12.0	0.5 ~ 3.0
RSLF0630	M6	9.0	9.0	13.0	1.5	20.0	14.0	0.5 ~ 3.0
RSLF0830	M8	11.0	11.0	16.0	1.5	20.0	16.0	0.5 ~ 3.0

PLEASE NOTE – NOT ALL STYLES & SIZES ARE HELD IN STOCK AT ALL TIMES. PLEASE CONTACT US TO CHECK AVAILABILITY. MINIMUM ORDER QUANTITIES APPLY.

Dafra Fastening Systems - Rivets Rivnuts & Tooling

1 / 7 Jarrah Dr, Braeside, VIC 3195, Australia

P: +61 3 9555 6872 | F: +61 3 9555 0803

E: sales@dafra.com.au | dafra.com.au

SKINPINS



Part Number	Description	Drill Size	Grip Range
SSL	1/8" Skin Pins – Yellow	#30	0 ~ 1/2"
SSL	5/32" Skin Pins – Blue	#21	0 ~ 1/2"
SSL	3/16" Skin Pins – Black	# 10	0 ~ 1/2"
SEL	1/8" Skin Pins – Yellow	#30	0 ~ 1"
SEL	5/32" Skin Pins – Blue	#21	0 ~ 1"
SEL	3/16" Skin Pins – Black	#10	0 ~ 1"
SEL	1/4" Skin Pins - White	#1/4"	0 ~ 1"

Our UK-made Skinpins Temporary Fasteners are widely used by leading aerospace companies throughout the world, including Airbus, BAE Systems and Boeing, while Formula 1, along with other motorsports and the general automotive industry, use Skinpins for body assembly. No matter how demanding your sheet metal assembly operations are, our genuine Skinpins rivet clamps provide you with a superior quality yet economical solution.

Dafra Fastening Systems - Rivets Rivnuts & Tooling

1 / 7 Jarrah Dr, Braeside, VIC 3195, Australia

P: +61 3 9555 6872 | F: +61 3 9555 0803

E: sales@dafra.com.au | dafra.com.au

